

APPROVAL - CUSTOMER NAME & SIGNATURE

DATE

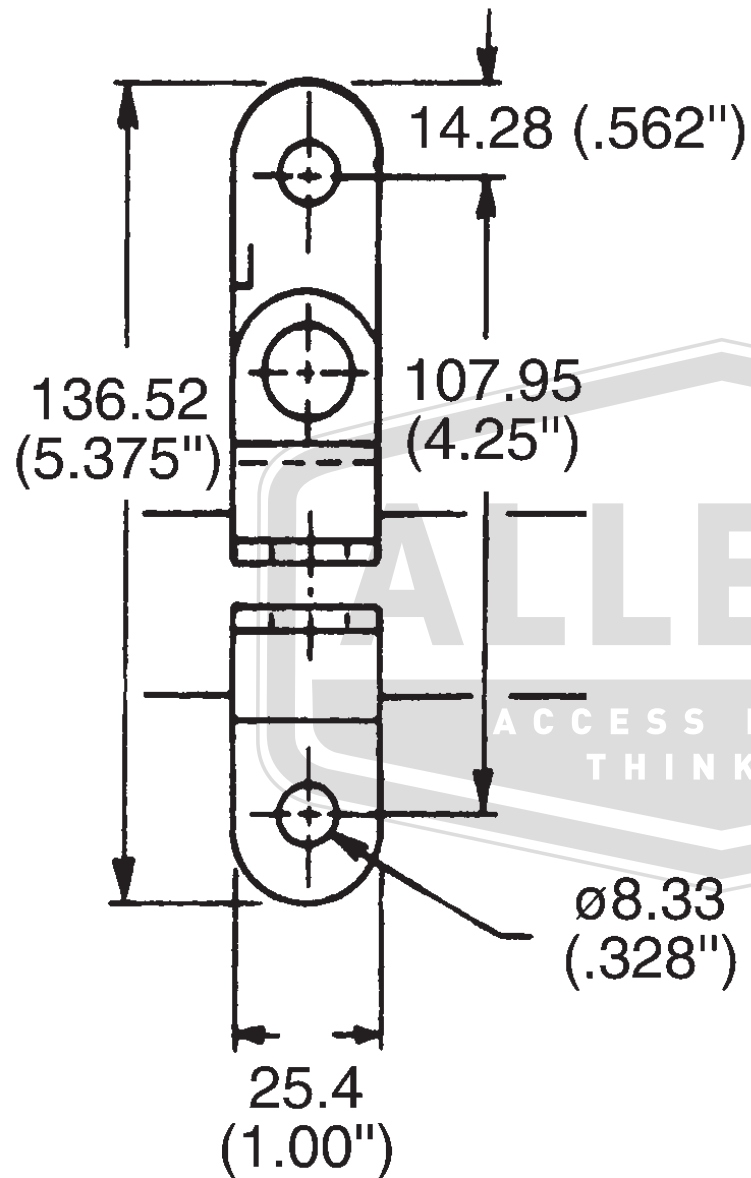

ALLEGIS	1-866-378-7550
MATERIAL:	DRAWING NO. : 158-101
FINISH:	
REV.: 1:1	DATE: 6/10/2019